

**FORCE** 起力  
S T R A P

# BROCHURE



**NINGBO FORCE RIGGING CO., LTD.**

**NINGBO FORCE AUTO PARTS CO., LTD.**

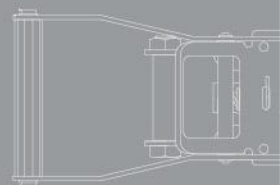





# ABOUT US >>>

Since its establishment in 2008, Ningbo Force Rigging Co.,Ltd., the company has been based on the tenet of "Quality first, competitive price, fast delivery, sincere and efficient service". In the past 16 years, with the efforts of the whole team of the company, we have developed from a factory of only 1000 square meters to a factory of more than 20000 square meters. We are quality ratchet tie down manufacturers and suppliers. We have cheap and high-quality ratchet tie down straps, and lifting slings, and all products have passed CE and TUV GS certifications. Our company has grown from a small factory with 20 workers to more than 200 employees and we have the ability to complete all production processes independently. The company has established a perfect enterprise management system and adopted a self production and self sales model, supplying more than 30 countries worldwide. In the past five years, the company's output has grown steadily at an annual rate of 20%, and its scale is also expanding. We have the ability and confidence to become the industry leader. If you trust us, please choose us as one of your suppliers and let us grow together for mutual benefit and win-win.

COMPANY PROFILE



OEM&ODM



DIVERSE TYPES



QUALITY



TIMELY DELIVERY



# QUALITY ASSURANCE IS TRUSTWORTHY

# CERTIFICATE

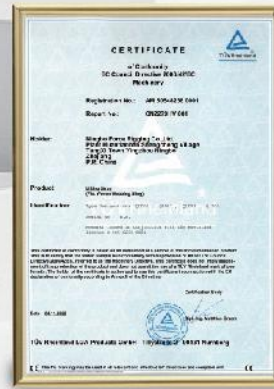



# PROCESS FLOW

1

IMPACT EXTRUSION

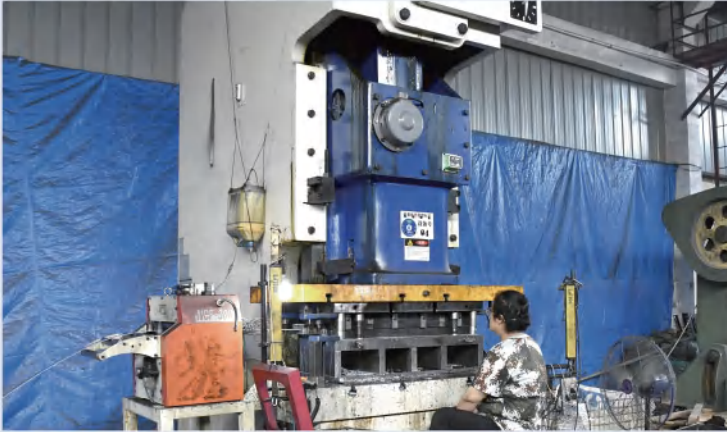

2

PATCHET ASSEMBLY



3

ON PROCESS



4

DYEING



5

PRINTING



6

CUTTING



7

SEWING



8

ASSEMBLY LINE



9

TESTING



10

PACKAGING



11

ENCASEMENT





# CONTENTS

<b>1</b>	<b>RATCHET STRAPS</b>	-----	01-03
	European Market	-----	04-05
	American Market	-----	06-07
	Winch Strap	-----	08-09
	Webbing	-----	10
<b>2</b>	<b>FLAT WEBBING SLING</b>	-----	11-13
<b>3</b>	<b>ROUND SLING</b>	-----	14-17
<b>4</b>	<b>PRODUCT SET SERIES</b>	-----	18-24
<b>5</b>	<b>TIE DOWN ACCESSORIES</b>	-----	25
	Ratchet Buckle	-----	26-30
	Over Centre Buckle	-----	31
	Cam Buckle	-----	32
	Wire Hook	-----	33-35
	Flat Hook	-----	36
	Snap Hook	-----	37
	Ring	-----	38-39
<b>6</b>	<b>E-TRACK SYSTEMS &amp; ATTACHMENT</b>	-----	40-47
<b>7</b>	<b>CHAIN / CHAIN BINDER</b>	-----	48-51
<b>8</b>	<b>CORNER PROTECTOR</b>	-----	52-53
<b>9</b>	<b>TRUCK WINCH</b>	-----	54-56
<b>10</b>	<b>FLAT TARPS</b>	-----	57-58

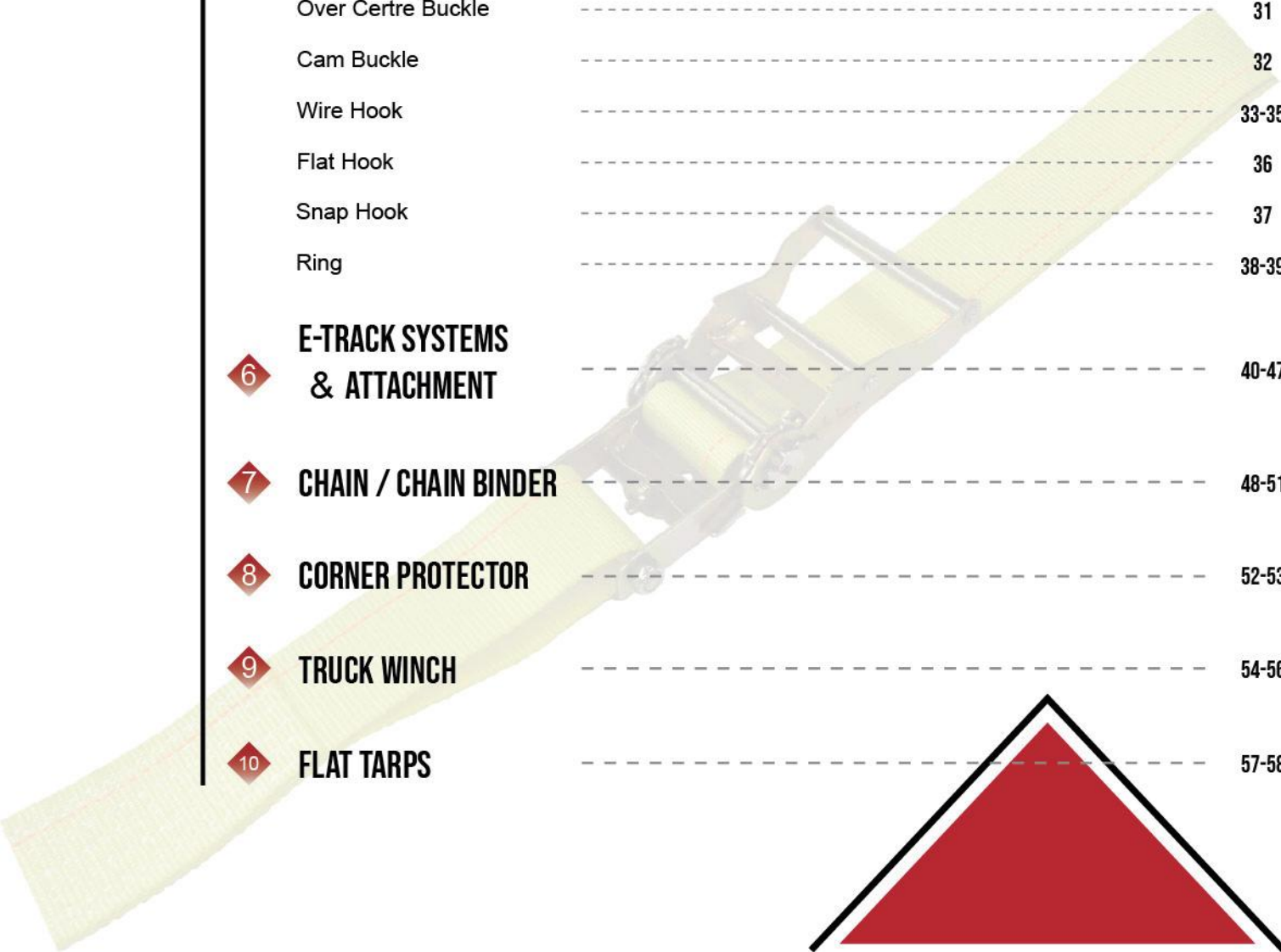



# RATCHET STRAPS



# CREATE YOUR OWN PRODUCT



In our portfolio, you will find standard products but as a manufacturer, we will give you the opportunity to figure your own product.

## CHOOSE LASHING CAPACITY

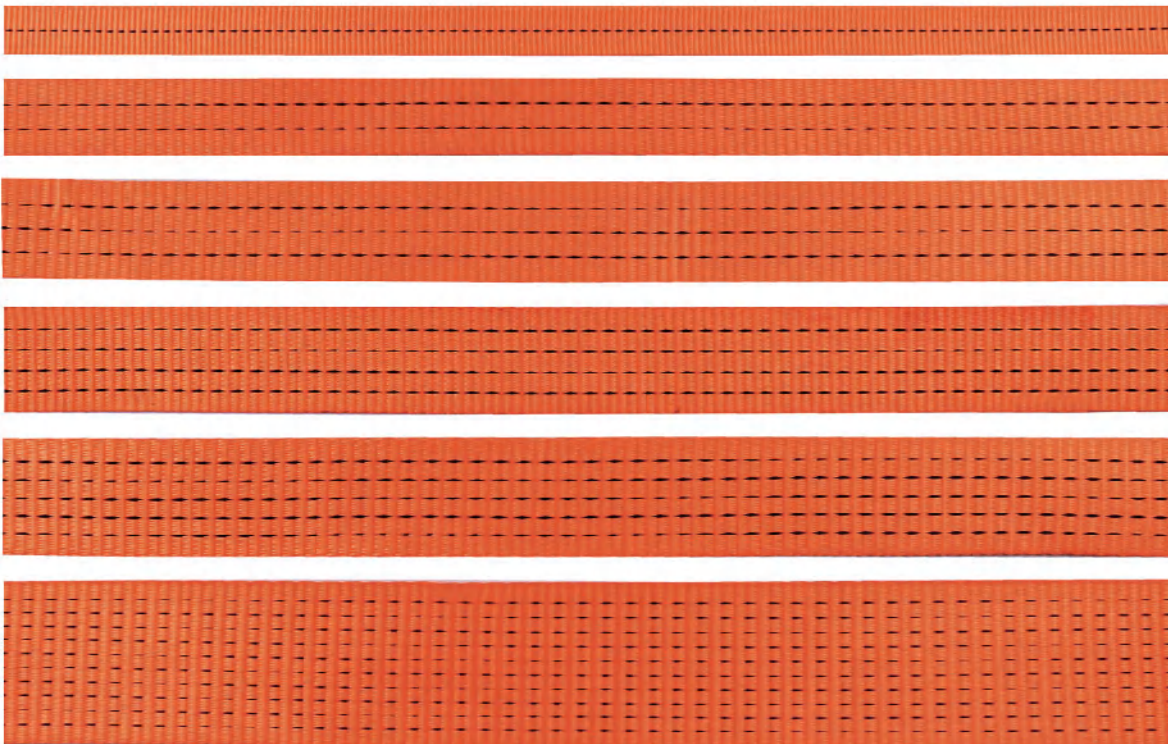

3/4TON  
LC:350 doNW  
IDTH:25cm

1TON  
LC:500 doNW  
IDTH:25cm

2TON  
LC:1000 doNW  
IDTH:35cm

3TON  
LC:1500 doNW  
IDTH:35cm

4TON  
LC:2000 doNW  
IDTH:50cm

5TON  
LC:2500 doNW  
IDTH:50cm

10TON  
LC:5000 doNW  
IDTH:75cm

We have different lashing capacities available for different applications and you should always consider the type of cargo you need to protect. Heavy duty calls for the most durable webbing available.



# CHOOSE WEBBING



Orange

Red

Yellow

Blue

Green

Black

Purple

Some colors have become the industry standard, but we have the ability to produce webbing in different colors.

# CHOOSE LENGTH

We have the ability to manufacture any length of webbing.

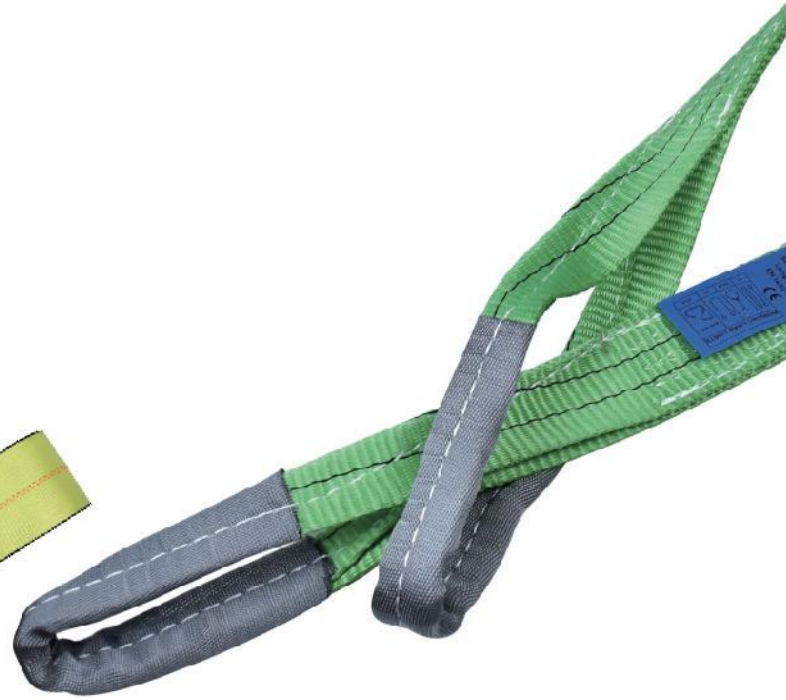

# CHOOSE HOOKTYPE

The most popular hook is the Double J hook, but we know that different goods or different industries create specific needs, which is why we offer a wide range of hooks.





**EUROPEAN MARKET**



Item No.	Width	B/S
QLEN50-001	50MM	5T



Item No.	Width	B/S
QLEN50-002	50MM	5T



Item No.	Width	B/S
QLEN50-003	50MM	5T



Item No.	Width	B/S
QLEN50-004	50MM	5T



Item No.	Width	B/S
QLEN50-005	50MM	5T



Item No.	Width	B/S
QLEN50-006	50MM	5T



Item No.	Width	B/S
QLEN38-001	38MM	3T



Item No.	Width	B/S
QLEN38-002	38MM	2T



Item No.	Width	B/S
QLEN38-003	38MM	2T



Item No.	Width	B/S
QLEN38-004	38MM	3T



Item No.	Width	B/S
QLEN50-007	50MM	5T



Item No.	width	B/S
QLEN50-008	50MM	5T



**EUROPEAN MARKET**



Item No.	Width	B/S
QLEN50-009	50MM	5T



Item No.	Width	B/S
QLEN38-005	38MM	3T



Item No.	Width	B/S
QLEN38-006	38MM	3T



Item No.	Width	B/S
QLEN38-007	38MM	3T



Item No.	Width	B/S
QLEN38-008	38MM	3T



Item No.	Width	B/S
QLEN50-010	50MM	5T



Item No.	Width	B/S
QLEN50-011	50MM	5T



Item No.	Width	B/S
QLEN38-009	38MM	2T



Item No.	Width	B/S
QLEN38-010	38MM	3T







# AMERICAN MARKET



Item No.	Width	W.L.L
QLUS50-001	2"	1450LBS



Item No.	Width	W.L.L
QLUS50-002	2"	1450LBS



Item No.	Width	W.L.L
QLUS50-003	2"	1100LBS



Item No.	Width	W.L.L
QLUS50-004	2"	1100LBS



Item No.	Width	W.L.L
QLUS75-001	3"	5400LBS



Item No.	Width	W.L.L
QLUS50-005	2"	1450LBS



Item No.	Width	W.L.L
QLUS50-006	2"	1100LBS



Item No.	Width	W.L.L
QLUS50-007	2"	3335LBS



Item No.	Width	W.L.L
QLUS50-008	2"	3335LBS



Item No.	Width	W.L.L
QLUS50-009	2"	3335LBS



Item No.	Width	W.L.L
QLUS50-010	2"	1450LBS



Item No.	Width	W.L.L
QLUS50-011	2"	1450LBS





**AMERICAN MARKET**



Item No.	Width	W.L.L
QLUS50-012	2"	3335LBS



Item No.	Width	W.L.L
QLUS50-013	2"	1450LBS



Item No.	Width	W.L.L
QLUS50-014	2"	1450LBS

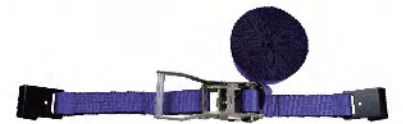

Item No.	Width	W.L.L
QLUS50-015	2"	3335LBS



Item No.	Width	W.L.L
QLUS75-002	3"	5400LBS



Item No.	Width	W.L.L
QLUS50-016	2"	3335LBS



Item No.	Width	W.L.L
QLUS50-017	2"	588LBS



Item No.	Width	W.L.L
QLUS50-018	2"	3335LBS



Item No.	Width	W.L.L
QLUS25-001	1"	588LBS



Item No.	Width	W.L.L
QLUS25-002	1"	588LBS



Item No.	Width	W.L.L
QLUS25-003	1"	600LBS



Item No.	Width	W.L.L
QLUS25-004	1"	600LBS





# WINCH STRAP

Trailer winch straps are one of the most common pieces of tie down equipment for flatbeds and other trailers. Used in combination with winches and other related hardware, their versatility makes them the ideal choice for a wide range of cargo. The rugged polyester webbing offers very little stretch and is abrasion-, UV-, and water-resistant.



Color	Width	W.L.L
Purple	4"	5400LBS



Color	Width	W.L.L
Green	4"	5400LBS



Color	Width	W.L.L
Yellow	4"	5400LBS



Color	Width	W.L.L
Gray	4"	5400LBS



Color	Width	W.L.L
Red	4"	5400LBS



Color	Width	W.L.L
Brown	4"	5400LBS



Color	Width	W.L.L
Blue	4"	5400LBS



Color	Width	W.L.L
Orange	4"	5400LBS



QLWS-001



◆ 4"X 5' Roll Off Container Winch Strap

QLWS-002



◆ 4"X30' Winch Strap With 18" Chain Extension

QLWS-003



◆ 4" Winch Strap With 34" Chain Extension

QLWS-004



◆ 4" Winch Strap With Grab Hook

QLWS-005



◆ 3" Winch Strap With Chain Extension

QLWS-006



◆ 2" Winch Strap With Chain Extension

QLWS-007



◆ 4"X5' Roll Off Container Strap With Sewn End Loop

QLWS-008



◆ 3" Winch Strap With Wire Hook





# POLYESTER WEBBING STRAP

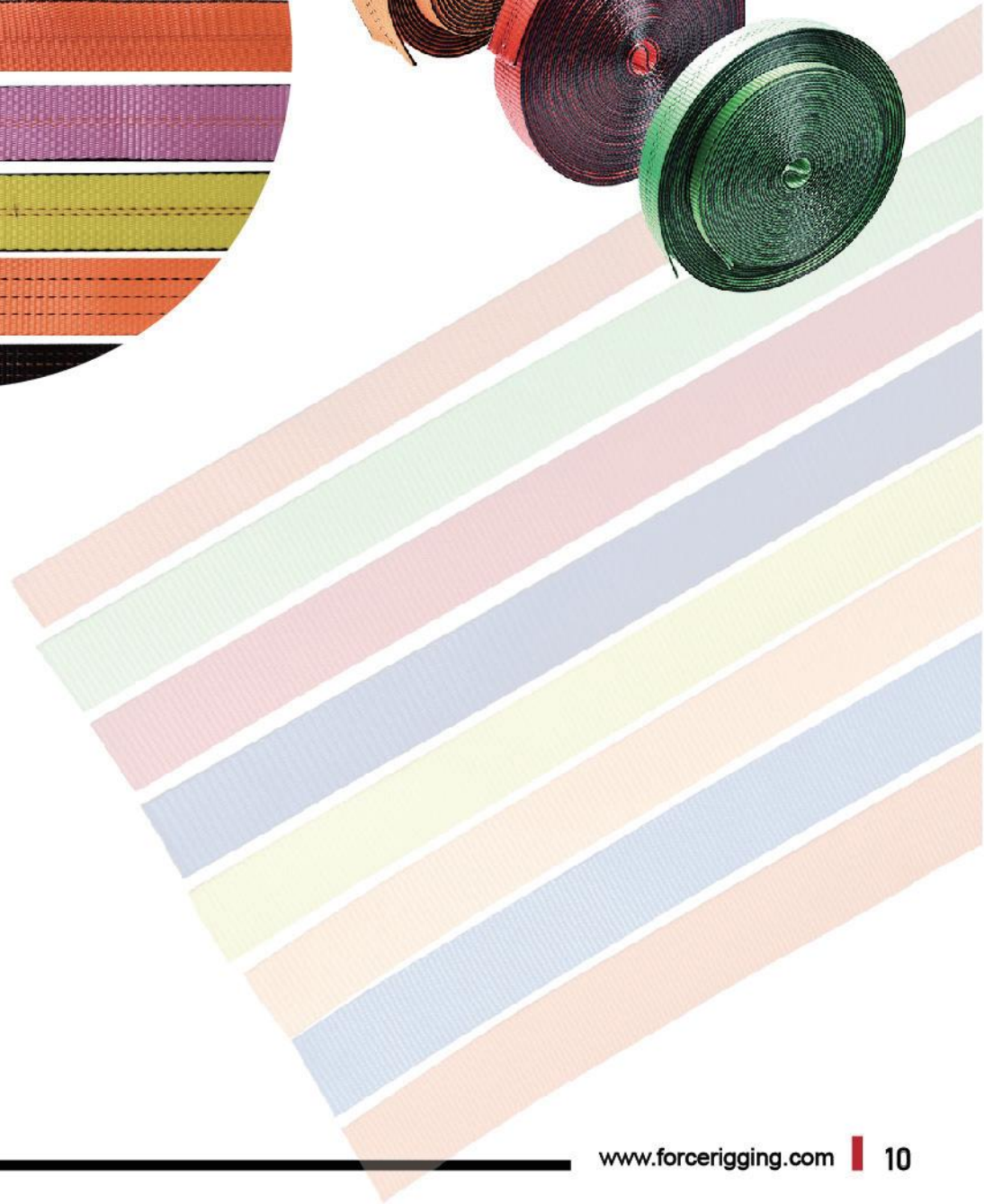





# FLAT WEBBING SLING



# FLAT WEBBING SLING



## Specification:











RE-useable webbing slings manufactured in accordance with BS 3481 Pt.2 1983 F:S 7:1(re-useable),DIN-EN 1492-1 and the essential requirements of the European Machinery Directive.

Color coded and stripped for WLL(working load limit) identification. Manufactured from 100% high tenacity continuous filament polyester fibre. All webbing slings are individually numbered and are fully traceable. Every single webbing sling is labeled and certificated in accordance with the relevant standard together with information about safety use and maintenance.













## Available:

Simplex, duplex & quadruplex ply standard slings, single and double endless slings, twin sling etc. In standard and long length up to 300mm width. With flat or becket (folded) eyes with or without re-reinforcement. Label printed with customer logo on request.

## Eye Types for Web sling

		Option 1: Flat eye
		Option 2: Reversed eye
		Option 3: Folded eye 1/2 width from 1 side
		Option 4: Folded eye 1/2 width from 2 sides
		Option 5: Folded eye 1/3 width

### EUROPEAN STANDARD PARAMETER:

Color according to EN-1492-1	Width in mm (SF 7:1)	Working Load Limit (WLL in kgs)				
		Vertical	Choker	Basket Lifting		
				A=0-7°	A=7-45°	A=45-60°
						
M=1.0	M=0.8	M=2.0	M=1.4	M=1.0		
 Purple (4005)	30	1000	800	2000	1400	1000
 Green (6018)	60	2000	1600	4000	2800	2000
 Yellow (1018)	90	3000	2400	6000	4200	3000
 Gray (7001)	120	4000	3200	8000	5600	4000
 Red (3020)	150	5000	4000	10000	7000	5000
 Brown (8003)	180	6000	4800	12000	8400	6000
 Blue (5015)	240	8000	6400	16000	11200	8000
 Orange (2008)	300	10000	8000	20000	14000	10000



### AMERICAN-STANDARD PARAMETER:

ASME Standard Eye-eye Flat Webbing Sling

PLY	Item No.	Width (inch)	Color	Rated Capacity (LBS)			
				Vertical	Choker	Basket	Eye Length (inch)
One Play	FS-A5SEE1600LBS	1"	Yellow	1600	1280	3200	10
	FS-A5SEE3200LBS	2"	Yellow	3200	2500	6400	12
	FS-A5SEE3800LBS	3"	Yellow	4800	3800	9600	14
	FS-A5SEE5000LBS	4"	Yellow	6400	5000	12800	14
	FS-A5SEE9600LBS	6"	Yellow	9600	7700	19200	16
	FS-A5SEE12800LBS	8"	Yellow	12800	10200	25600	20
	FS-A5SEE16000LBS	10"	Yellow	16000	12800	32000	24
	FS-A5SEE19200LBS	12"	Yellow	19200	15400	38400	24
Two Play	FS-A5DEE3200LBS	1"	Yellow	3200	2500	6200	10
	FS-A5DEE6400LBS	2"	Yellow	6400	5000	12400	12
	FS-A5DEE8800LBS	3"	Yellow	8800	7040	17600	14
	FS-A5DEE12000LBS	4"	Yellow	12000	9600	24000	14
	FS-A5DEE16500LBS	6"	Yellow	16500	13200	33000	16
	FS-A5DEE19200LBS	8"	Yellow	19200	15400	38400	20
	FS-A5DEE17900LBS	10"	Yellow	22400	17900	44800	24
	FS-A5DEE21500LBS	12"	Yellow	26900	21500	53800	24



# ROUND SLING





# ROUND SLING

## Specification:

Manufactured in accordance with BS 6668 Pt.2 1987, DIN-EN 1492-2 and essential requirements of European Machinery Directive. The load bearing core of a round sling is manufactured from 100% high tenacity continuous filament polyester fibre which is protected by an abrasion resistance tubular polyester webbing cover.



Color coded and striped for WLL(Working Load Limit) identification. All round slings are individually numbered and are fully traceable. Every single round sling is labeled and certificated in accordance with relevant standard together with information about safety use and maintenance.

## Available:

In lengths up to 18 meter working(36m circumference). Capacity up to 20 ton WLL(Working Load Limit) per sling. Label printed with customer logo on request.





**EUROPEAN STANDARD PARAMETER:**

According to EN1492-2:2000 (SF=7:1)

Stock.No Color	WLL	SWL WLL (T) M CC					Double Multi-set SWL (T)			
				0-7°	7-45°	45-60°	<45°	<45°	45-60°	45-60°
		1	0.8	2	1.4	1	1.4	1.12	1	0.8
E7RS010	WLL 1T	1000	800	2000	1400	1000	2800	1120	1000	800
E7RS020	WLL 2T	2000	1600	4000	2800	2000	5600	2240	2000	1600
E7RS030	WLL 3T	3000	2400	6000	4200	3000	8400	3360	3000	2400
E7RS040	WLL 4T	4000	3200	8000	5600	4000	11200	4480	4000	3200
E7RS050	WLL 5T	5000	4000	10000	7000	5000	14000	5600	5000	4000
E7RS060	WLL 6T	6000	4800	12000	8400	6000	16800	6720	6000	4800
E7RS080	WLL 8T	8000	6400	16000	11200	8000	22400	8960	8000	6400
E7RS100	WLL 10T	10000	8000	20000	14000	10000	28000	11200	10000	8000
E7RS120	WLL 12T	12000	9600	24000	16800	12000	33600	13440	12000	9600



**AMERICAN-STANDARD PARAMETER:**

ASME standard Endless Round Sling







Stock. NoColor	Item No.	SleeveWidth (mm)	Working Load Limit (LBS)				Body diameter (inch)	Min. length (FT)
			Vertical	Choker	Basket 90°	Basket 45°		
Purple	RS-A5EN2600	44-45	2600	2100	5200	3600	0.63	3
Green	RS-A5EN5300	54-55	5300	4200	10600	7400	0.88	3
Yellow	RS-A5EN8400	63-64	8400	6700	16800	11800	1.13	3
Tan	RS-A5EN12000	68-70	12000	8500	21200	14000	1.13	3
Red	RS-A5EN13200	78-80	13200	10600	26400	18000	1.38	3
Orange	RS-A5EN17000	83-85	17000	13400	33600	23000	1.38	6
Blue	RS-A5EN21200	95-98	21200	17000	42400	29000	1.75	6
Orange	RS-A5EN26000	100-105	26000	20000	50000	35000	1.87	6
Grey	RS-A5EN31000	110-115	31000	24800	62000	43000	2.25	6
Orange	RS-A5EN40000	125-130	40000	32000	80000	56000	2.5	8
Brown	RS-A5EN54000	130-135	54000	42400	106000	74000	2.75	8
Olive	RS-A5EN68000	135-140	68000	52800	132000	93000	3.13	8
Black	RS-A5EN90000	145-150	90000	72000	180000	127000	3.63	8

**AMERICAN-STANDARD PARAMETER:**

ASME standard Eye to Eye Round Sling



Stock.No Color	Item No.	SleeveWidth (mm)	Working Load Limit (LBS)				Body diameter (inch)	Min. length (FT)
			 Vertical	 Choker	 Basket 90°	 Basket 45°		
Purple	RS-A5EE2600	44-45	2600	2100	5200	3600	0.63	3
Green	RS-A5EE5300	54-55	5300	4200	10600	7400	0.88	3
Yellow	RS-A5EE8400	63-64	8400	6700	16800	11800	1.13	3
Tan	RS-A5EE12000	68-70	12000	8500	21200	14000	1.13	3
Red	RS-A5EE13200	78-80	13200	10600	26400	18000	1.38	3
Orange	RS-A5EE17000	83-85	17000	13400	33600	23000	1.38	6
Blue	RS-A5EE21200	95-98	21200	17000	42400	29000	1.75	6
Orange	RS-A5EE26000	100-105	26000	20000	50000	35000	1.87	6
Grey	RS-A5EE31000	110-115	31000	24800	62000	43000	2.25	6
Orange	RS-A5EE40000	125-130	40000	32000	80000	56000	2.5	8
Brown	RS-A5EE54000	130-135	54000	42400	106000	74000	2.75	8
Olive	RS-A5EE68000	135-140	68000	52800	132000	93000	3.13	8
Black	RS-A5EE90000	145-150	90000	72000	180000	127000	3.63	8







# PRODUCT SET SERIES





**QL25-001**

◆ 1"B.S. 1500LBS  
Ratchet Tie Down 1pcs Pack



**QL25-002**

◆ 1"B.S. 1500LBS  
Ratchet Tie Down 1pcs Pack



**QL25-003**

◆ 1"B.S. 1500LBS  
Ratchet Tie Down 1pcs Pack



**QL25-004**

◆ 1"B.S. 1500LBS  
Ratchet Tie Down 1pcs Pack

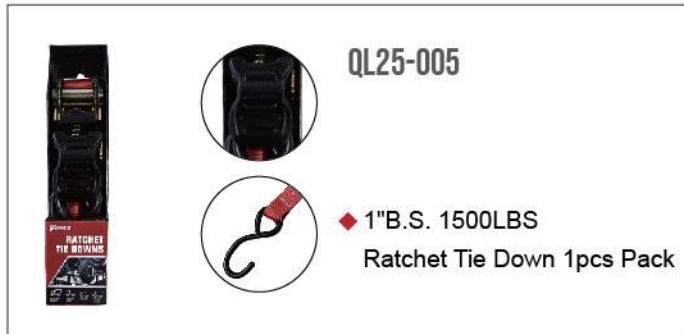

**QL25-005**

◆ 1"B.S. 1500LBS  
Ratchet Tie Down 1pcs Pack



**QL25-006**

◆ 1"B.S. 1500LBS  
Ratchet Tie Down 1pcs Pack



**QL25-007**

◆ 1"B.S. 1500LBS  
Ratchet Tie Down 1pcs Pack

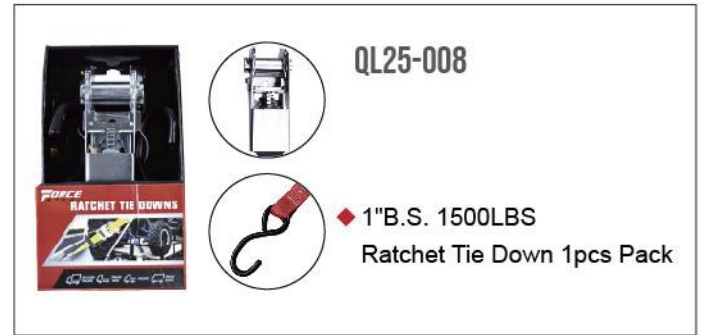

**QL25-008**

◆ 1"B.S. 1500LBS  
Ratchet Tie Down 1pcs Pack



**QL25-009**

◆ 1"B.S. 1500LBS  
Cam Buckle Strap 1pcs Pack

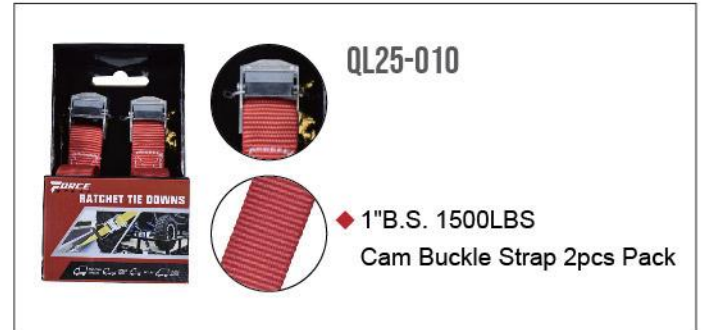

**QL25-010**

◆ 1"B.S. 1500LBS  
Cam Buckle Strap 2pcs Pack





**QL25-011**



◆ 1"B.S. 1500LBS  
Ratchet Tie Down 2 pcs Pack





**QL25-012**



◆ 1"B.S. 1500LBS  
Ratchet Tie Down 2 pcs Pack



**QL25-013**



◆ 1"B.S. 1500LBS  
Ratchet Tie Down 2 pcs Pack



**QL25-014**



◆ 1"B.S. 1500LBS  
Cam Buckle Strap 2 pcs Pack



**QL25-015**



◆ 1"B.S. 2000LBS  
Cam Buckle Strap 1 pcs Pack



**QL25-016**





◆ 1"B.S. 1500LBS  
Ratchet Tie Down 2 pcs Pack



**QL25-017**



◆ 1"B.S. 1500LBS  
Ratchet Tie Down 1 pcs Pack

**QL25-018**



◆ 1"B.S. 1500LBS  
Ratchet Tie Down 2 pcs Pack



**QL25-019**



◆ 1"B.S. 1500LBS  
Cam Buckle Strap 2 pcs Pack



**QL25-020**



◆ 1"B.S. 1500LBS  
Ratchet Tie Down 1 pcs Pack









**QL25-021**

◆ 1"B.S. 1500LBS  
Ratchet Tie Down 2 pcs Pack

**QL25-022**

◆ 1"B.S. 1500LBS  
Ratchet Tie Down 2 pcs Pack





**QL25-023**

◆ 1"B.S. 1500LBS  
Ratchet Tie Down 2 pcs Pack





**QL25-024**

◆ 1"B.S. 1500LBS  
Ratchet Tie Down 2 pcs Pack





**QL38-001**



◆ 1.5"B.S. 5500LBS  
Ratchet Tie Down 2 pcs Pack





**QL50-001**

◆ 2"B.S. 10000LBS  
Ratchet Tie Down 1 pcs Pack

**QL25-025**

◆ 1"B.S. 1500LBS  
Ratchet Tie Down 2 pcs Pack





**QL50-002**

◆ 2"B.S. 10000LBS  
Ratchet Tie Down 1 pcs Pack





**QL38-002**

◆ 1.5"B.S. 5500LBS  
Ratchet Tie Down 1 pcs Pack





**QL38-003**

◆ 1.5"B.S. 1500LBS  
Ratchet Tie Down 1 pcs Pack







**QL38-004**

◆ 1.5"B.S. 5500LBS  
Ratchet Tie Down 1pcs Pack





**QL25-026**

◆ 1"B.S. 1500LBS  
Ratchet Tie Down 2 pcs Pack





**QL38-005**



◆ 1.5"B.S. 5500LBS  
Ratchet Tie Down 2 pcs Pack





**QL50-003**

◆ 2"B.S. 10000LBS  
Ratchet Tie Down 1pcs Pack

**QL25-027**

◆ 1"B.S. 1500LBS  
Ratchet Tie Down 2 pcs Pack





**QL50-004**

◆ 2"B.S. 10000LBS  
Ratchet Tie Down 1pcs Pack





**QL25-028**

◆ 1"B.S. 1500LBS  
Ratchet Tie Down 4 pcs Pack





**QL25-029**

◆ 1"B.S. 1500LBS  
Ratchet Tie Down 4 pcs Pack





**QL25-030**

◆ 1"B.S. 1500LBS  
Ratchet Tie Down 4 pcs Pack





**QL25-031**

◆ 1"B.S. 1500LBS  
Ratchet Tie Down 4 pcs Pack



**QL25-032**



◆ 1"B.S. 1500LBS  
Ratchet Tie Down 1 pcs Pack



**QL25-033**



◆ 1"B.S. 1500LBS  
Ratchet Tie Down 1 pcs Pack



**QL25-034**



◆ 1"B.S. 1500LBS  
Ratchet Tie Down 1 pcs Pack



**QL25-035**



◆ 1"B.S. 1500LBS  
Ratchet Tie Down 1 pcs Pack



**QL25-036**



◆ 1"B.S. 1500LBS  
Ratchet Tie Down 1 pcs Pack



**QL38-006**





◆ 1.5"B.S. 5500LBS  
Ratchet Tie Down 1 pcs Pack





**QL50-005**



◆ 2"B.S. 10000LBS  
Ratchet Tie Down 1 pcs Pack

**QL25-037**



◆ 1"B.S. 1500LBS  
Cam Buckle Strap 2 pcs Pack



**QL25-038**



◆ 1"B.S. 1500LBS  
Ratchet Tie Down 2 pcs Pack



**QL25-039**



◆ 1"B.S. 1500LBS  
Ratchet Tie Down 1 pcs Pack







**QL50-006**

◆ 2"B.S. 10000LBS  
Ratchet Tie Down 1pcs Pack





**QL25-040**

◆ 1"B.S. 1500LBS  
Ratchet Tie Down 1pcs Pack





**QL38-007**

◆ 1.5"B.S. 5500LBS  
Cam Buckle Strap 1pcs Pack





**QL38-008**

◆ 1.5"B.S. 4400LBS  
Ratchet Tie Down 1pcs Pack





**QL38-009**

◆ 1.5"B.S. 6600LBS  
Ratchet Tie Down 1pcs Pack





**QL50-007**

◆ 2"B.S. 10000LBS  
Ratchet Tie Down 1pcs Pack





**QL50-008**

◆ 2"B.S. 10000LBS  
Ratchet Tie Down 1pcs Pack





**QL50-009**

◆ 1"B.S. 2000LBS  
Ratchet Tie Down 1pcs Pack





**QL50-010**

◆ 2"B.S. 10000LBS  
Ratchet Tie Down 1pcs Pack





**QL25-041**

◆ 1"B.S. 1500LBS  
Ratchet Tie Down 4 pcs Pack



# TIE DOWN ACCESSORIES

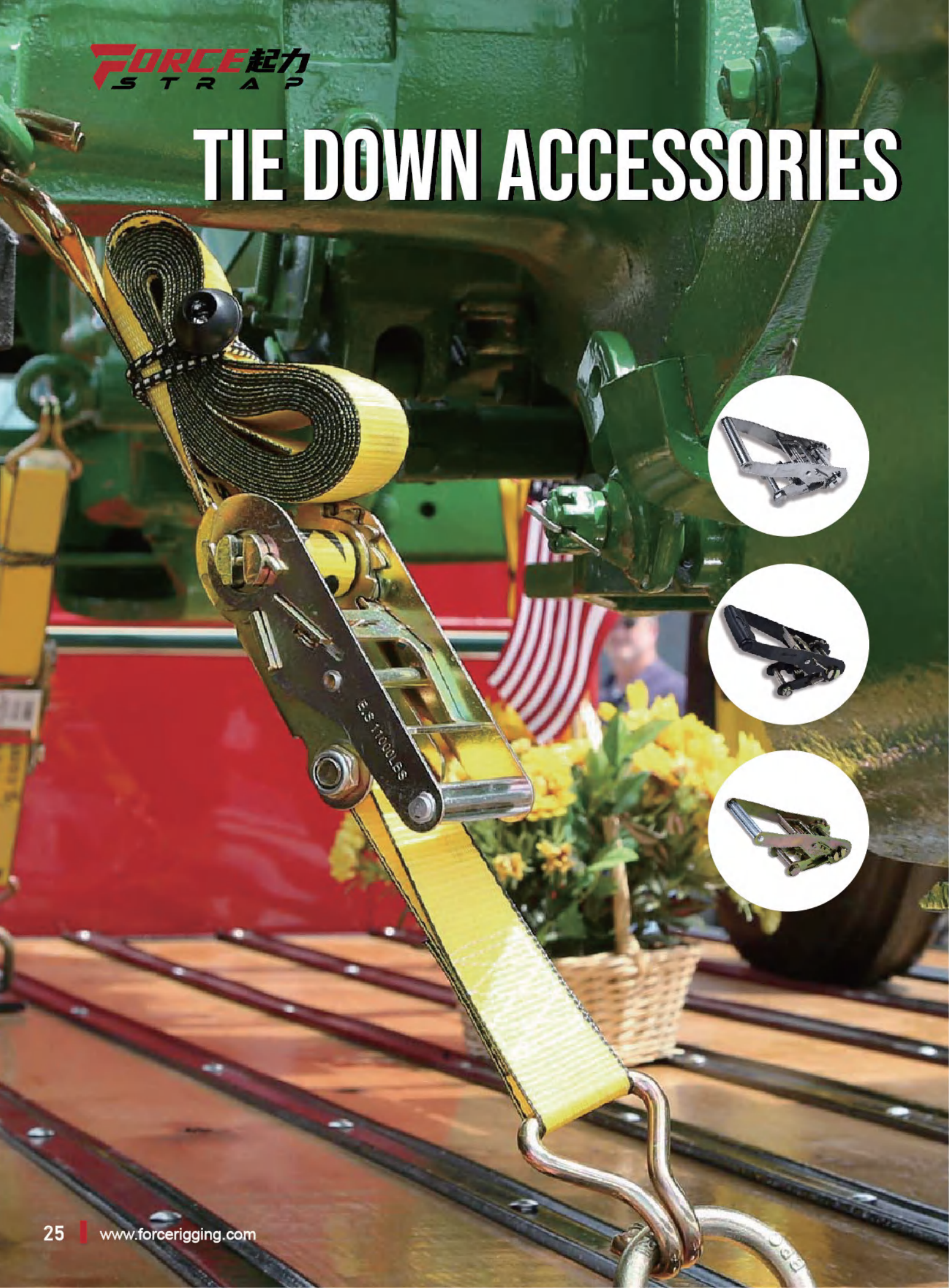



# RATCHET BUCKLE //

**QL29**

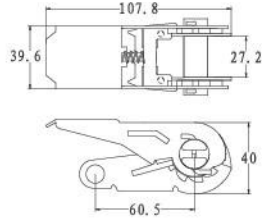

◆ Width: 25mm  
B/S: 800KG  
100PCS/CTN,G.W/N.W:23.5KG/22.5KG

**QL29 Stainless Steel**

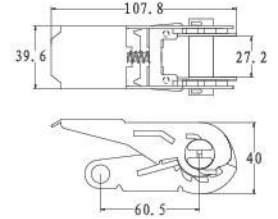

◆ Width: 25mm  
B/S: 800KG  
100PCS/CTN,G.W/N.W:23KG/22KG

**QL29N**

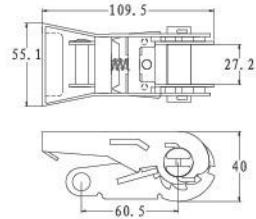

◆ Width: 25mm  
B/S: 800KG  
100PCS/CTN,G.W/N.W:24KG/23KG

**QL29A**

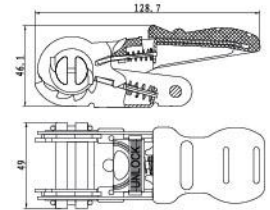

◆ Width: 25mm  
B/S: 800KG  
100PCS/CTN,G.W/N.W:23KG/22KG

**QL29B**

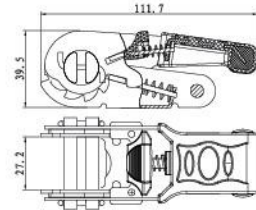

◆ Width: 25mm  
B/S: 800KG  
100PCS/CTN,G.W/N.W:22KG/21KG

**QL25**

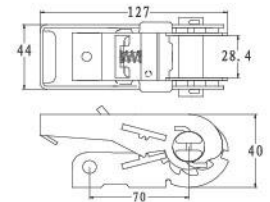

◆ Width: 25mm  
B/S: 1500KG  
40PCS/CTN,G.W/N.W:15KG/14KG

**QL26**

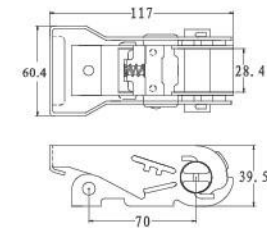

◆ Width: 25mm  
B/S: 1500KG  
40PCS/CTN,G.W/N.W:15KG/14KG

**QL26C**

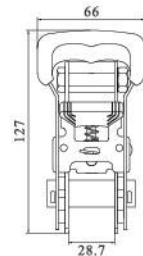

◆ Width: 25mm  
B/S: 1875KG  
40PCS/CTN,G.W/N.W:15KG/14KG

**QL26 Stainless Steel**

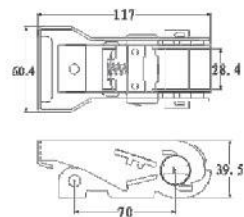

◆ Width: 25mm  
B/S: 1500KG  
40PCS/CTN,G.W/N.W:16KG/15KG

**QL27**

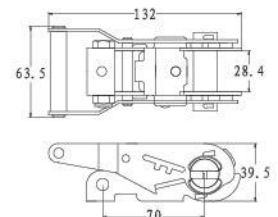

◆ Width: 25mm  
B/S: 1500KG  
40PCS/CTN,G.W/N.W:15KG/14KG

QL35

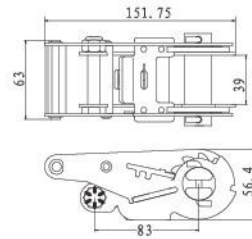

◆ Width: 35mm  
B/S: 3000KG  
20PCS/CTN,G.W/N.W:17KG/16KG

QL33

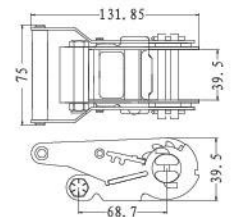

◆ Width: 35mm  
B/S: 2000KG  
40PCS/CTN,G.W/N.W:19KG/18KG

QL38A

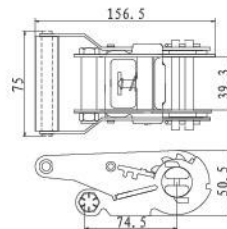

◆ Width: 35mm  
B/S: 3500KG  
20PCS/CTN,G.W/N.W:12KG/11KG

QL32

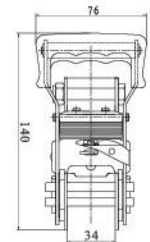

◆ Width: 35mm  
B/S: 2500KG  
40PCS/CTN,G.W/N.W:19KG/18KG

QL32A

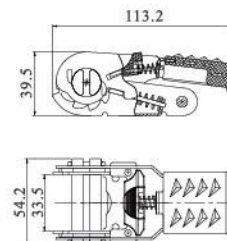

◆ Width: 35mm  
B/S: 910KG  
840PCS/CTN,G.W/N.W:19KG/18KG

QL32C

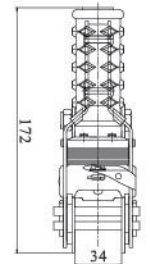

◆ Width: 35mm  
B/S: 1500KG  
40PCS/CTN,G.W/N.W:20KG/19KG

QL31R-A

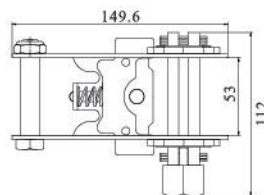

◆ Width: 50mm  
B/S: 3000KG  
20PCS/CTN,G.W/N.W:17KG/16KG

QL38F

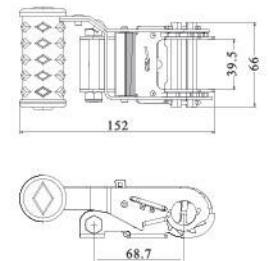

◆ Width: 35mm  
B/S: 1500KG  
40PCS/CTN,G.W/N.W:20KG/19KG

QL38E

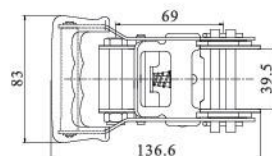

◆ Width: 35mm  
B/S: 2000KG  
50PCS/CTN,G.W/N.W:22KG/23KG

QL53Z

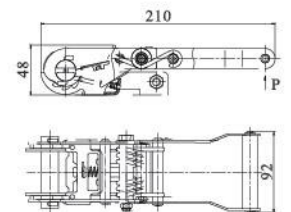

◆ Width: 50mm  
B/S: 2000KG  
15PCS/CTN,G.W/N.W:11KG/12KG



# RATCHET BUCKLE //

**QL53**

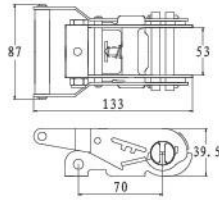

◆ Width: 50mm  
B/S: 2000KG  
40PCS/CTN,G.W/N.W:22KG/21KG

**QL53B**

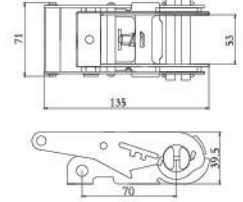

◆ Width: 50mm  
B/S: 2000KG  
40PCS/CTN,G.W/N.W:21KG/20KG

**QL45**

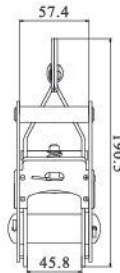

◆ Width: 45mm  
B/S: 3000KG  
20PCS/CTN,G.W/N.W:16KG/17KG

**QL45A**

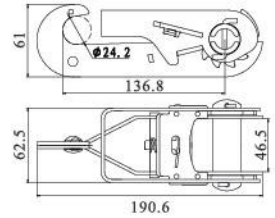

◆ Width: 45mm  
B/S: 2900KG  
50PCS/CTN,G.W/N.W:17KG/16KG

**QL50P**

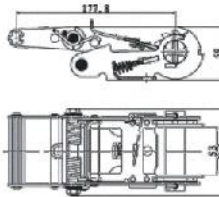

◆ Width: 50mm  
B/S: 5000KG  
20PCS/CTN,G.W/N.W:24KG/23KG

**QL54**

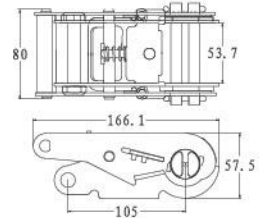

◆ Width: 50mm  
B/S: 5000KG  
20PCS/CTN,G.W/N.W:22KG/21KG

**QL51**

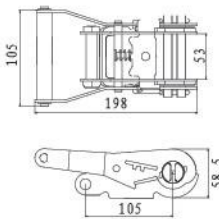

◆ Width: 50mm  
B/S: 5000KG  
20PCS/CTN,G.W/N.W:22KG/21KG

**QL50**

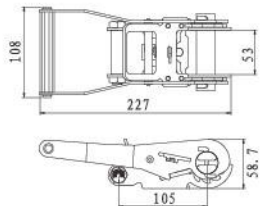

◆ Width: 50mm  
B/S: 5000KG  
20PCS/CTN,G.W/N.W:23KG/22KG

**QL51G**

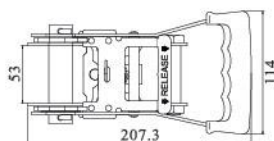

◆ Width: 50mm  
B/S: 5000KG  
10PCS/CTN,G.W/N.W:16.5KG/17.5KG

**QL50S**

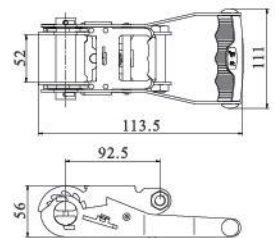

◆ Width: 50mm  
B/S: 5000KG  
20PCS/CTN,G.W/N.W:20KG/19KG

**QL53B**

◆ Width: 50mm  
B/S: 5000KG  
20PCS/CTN,G.W/N.W:21KG/20KG

**QL50SG**

◆ Width: 50mm  
B/S: 5000KG  
15PCS/CTN,G.W/N.W:22KG/21KG

**QL50SJ**

◆ Width: 50mm  
B/S: 5000KG  
14PCS/CTN,G.W/N.W:20.5KG/19.5KG

**QL50ST**

◆ Width: 50mm  
B/S: 5000KG  
10PCS/CTN,G.W/N.W:22KG/21KG

**QL50SU**

◆ Width: 50mm  
B/S: 5000KG  
16PCS/CTN,G.W/N.W:26.5KG/25.5KG

**QL75**

◆ Width: 75mm  
B/S: 10000KG  
20PCS/CTN,G.W/N.W:17KG/16KG

**QL100**

◆ Width: 100mm  
B/S: 10000KG  
6PCS/CTN,G.W/N.W:19KG/18KG

**QL50**

◆ Width: 150mm  
B/S: 20000KG  
2PCS/CTN,G.W/N.W:23.5KG/22.5KG

**QLRB-001**

◆ Width: 1" B/S: 800KG

**QLRB-002**

◆ Width: 1" B/S: 800KG

**QLRB-003**

◆ Width: 1" B/S: 800KG

**QLRB-004**









◆ Width: 1" B/S: 800KG

**QLRB-005**

◆ Width: 1" B/S: 800KG



# RATCHET BUCKLE //

<p>QLRB-007</p>  <p>◆ Width: 1.5" B/S: 2T</p>	<p>QLRB-008</p>  <p>◆ Width: 2" B/S: 2T</p>	<p>QLRB-009</p>  <p>◆ Width: 11/16" B/S: 1.5T</p>	<p>QLRB-010</p>  <p>◆ Width: 11/16" B/S: 1.5T</p>	<p>QLRB-011</p>  <p>◆ Width: 1.5" B/S: 2T</p>
<p>QLRB-012</p>  <p>◆ Width: 2" B/S: 2T</p>	<p>QLRB-013</p>  <p>◆ Width: 1.5" B/S: 2T</p>	<p>QLRB-014</p>  <p>◆ Width: 1.5" B/S: 2.5T</p>	<p>QLRB-015</p>  <p>◆ Width: 1.5" B/S: 2.5T</p>	<p>QLRB-016</p>  <p>◆ Width: 1.5" B/S: 2T</p>
<p>QLRB-017</p>  <p>◆ Width: 2" B/S: 3T</p>	<p>QLRB-018</p>  <p>◆ Width: 2" B/S: 3T</p>	<p>QLRB-019</p>  <p>◆ Width: 2" B/S: 5T</p>	<p>QLRB-020</p>  <p>◆ Width: 2" B/S: 5T</p>	<p>QLRB-021</p>  <p>◆ Width: 2" B/S: 5T</p>
<p>QLRB-022</p>  <p>◆ Width: 2" B/S: 5T</p>	<p>QLRB-023</p>  <p>◆ Width: 2" B/S: 5T</p>	<p>QLRB-024</p>  <p>◆ Width: 2" B/S: 5T</p>	<p>QLRB-025</p>  <p>◆ Width: 2" B/S: 5T</p>	<p>QLRB-026</p>  <p>◆ Width: 2" B/S: 5T</p>
<p>QLRB-027</p>  <p>◆ Width: 2" B/S: 5T</p>	<p>QLRB-028</p>  <p>◆ Width: 2" B/S: 5T</p>	<p>QLRB-029</p>  <p>◆ Width: 2" B/S: 5T</p>	<p>QLRB-030</p>  <p>◆ Width: 2" B/S: 5T</p>	<p>QLRB-031</p>  <p>◆ Width: 2" B/S: 5T</p>

**OVER CENTRE BUCKLE //**

**QLB13**

◆ Width: 50mm  
B/S: 860KG  
100PCS/CTN,G.W/N.W:28KG/27 KG

**QL915N**

◆ Width: 45mm  
B/S: 1500KG  
80PCS/CTN,G.W/N.W:28.5KG/27.5KG

**QL914**

◆ Width: 45mm  
B/S: 2250KG  
80PCS/CTN,G.W/N.W:29KG/28KG

**QL913**

◆ Width: 45mm  
B/S: 2250KG  
40PCS/CTN,G.W/N.W:21KG/20KG

**QL911**

◆ Width: 45mm  
B/S: 2250KG  
40PCS/CTN,G.W/N.W:25KG/24KG

**QLB17A**

◆ Width: 45mm  
B/S: 2250KG  
40PCS/CTN,G.W/N.W:25KG/24KG

**QLOB-001**

◆ Width: 45mm  
B/S: 1200KG

**QLOB-002**

◆ Width: 45mm  
B/S: 1200KG

**QLOB-003**

◆ Width: 45mm  
B/S: 1360KG

**QLOB-004**

◆ Width: 45mm  
B/S: 1200KG

**QLOB-005**

◆ Width: 45mm  
B/S: 1360KG

**QLOB-006**

◆ Width: 45mm  
B/S: 1360KG

**QLOB-007**

◆ Width: 45mm  
B/S: 800KG

**QLOB-008**

◆ Width: 45mm  
B/S: 600KG



# CAM BUCKLE //

**QL06**

◆ Width: 25mm  
B/S: 300KG  
400PCS/CTN,G.W/N.W:31.5KG/30.5KG

**QL05**

◆ Width: 25mm  
B/S: 700KG  
200PCS/CTN,G.W/N.W:23KG/22KG

**QL05N**

◆ Width: 25mm  
B/S: 800KG  
150PCS/CTN,G.W/N.W:28KG/27KG

**QL03**

◆ Width: 50mm  
B/S: 1100KG  
100PCS/CTN,G.W/N.W:27KG/26KG

**QLCB-001**

◆ Width: 26mm  
B/S: 450KG

**QLCB-002**

◆ Width: 26mm  
B/S: 400KG

**QLCB-003**

◆ Width: 38mm  
B/S: 600KG

**QLCB-004**

◆ Width: 25mm  
B/S: 800KG

**QLCB-005**

◆ Width: 38mm  
B/S: 600KG

**QLCB-006**

◆ Width: 38mm  
B/S: 700KG

**QLCB-007**

◆ Width: 28mm  
B/S:700KG

**QLCB-008**

◆ Width: 26mm  
B/S: 700KG

# WIRE HOOK //

Item No.	B/S KG	A mm	B mm	C mm	D mm	Q'ty PCS/CTN	G.W KG	N.W KG
S50	220	107	25	28	8	250	24	23
S150	700	107	25	28	8	250	24	23
S220	1000	108	25	25	8.5	250	24.5	23.5
S250	1100	120	27	33	9.5	120	18	17
S330	1500	121	28	28	10	120	19	18

Color Zinc  
Vinyl Coated  
White Zinc

**QL307**

◆ Width: 25mm  
B/S: 1350KG  
400PCS/CTN,G.W/N.W:23KG/22KG

**QL307A**

◆ Width: 25mm  
B/S: 1500KG  
300PCS/CTN,G.W/N.W:25KG/24KG

**QL303**

◆ Width: 25mm  
B/S: 1100KG  
400PCS/CTN,G.W/N.W:18.5KG/17.5KG

**QL313**

◆ Width: 25mm  
B/S: 1500KG  
200PCS/CTN,G.W/N.W:31KG/30KG

**QL308+D21A**

◆ Width: 25mm  
B/S: 1500KG  
200PCS/CTN,G.W/N.W:25KG/24KG

**QL302A**

◆ Width: 45mm  
B/S: 3000KG  
100PCS/CTN,G.W/N.W:18.5KG/17.5KG

**QL317**

◆ Width: 35mm  
B/S: 2000KG  
200PCS/CTN,G.W/N.W:27KG/26KG

**QL316**

◆ Width: 35mm  
B/S: 2000KG  
200PCS/CTN,G.W/N.W:21KG/20KG

**QL314**

◆ Width: 35mm  
B/S: 3000KG  
50PCS/CTN,G.W/N.W:15.5KG/15KG

**QL400**

◆ Width: 45mm  
B/S: 450KG  
300PCS/CTN,G.W/N.W:22KG/21KG



**WIRE HOOK**

QL310A

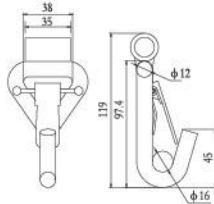

◆ Width: 35mm  
B/S: 3000KG  
50PCS/CTN, G.W/N.W: 15KG/14.5KG

QL315+D24

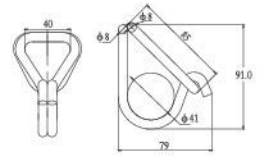

◆ Width: 40mm  
B/S: 3000KG  
100PCS/CTN, G.W/N.W: 26KG/25KG

QL302

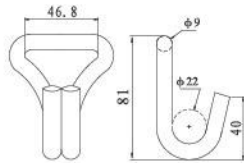

◆ Width: 45mm  
B/S: 3000KG  
100PCS/CTN, G.W/N.W: 21.5KG/20.5KG

QL504

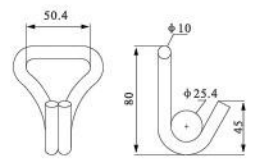

◆ Width: 50mm  
B/S: 2250KG  
100PCS/CTN, G.W/N.W: 20KG/19KG

QL304

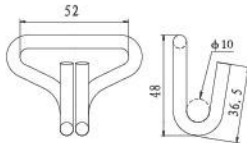

◆ Width: 50mm  
B/S: 1100KG  
400PCS/CTN, G.W/N.W: 24.5KG/23.5KG

QL501

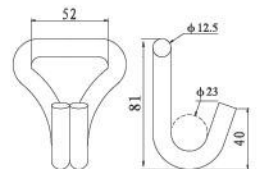

◆ Width: 50mm  
B/S: 5000KG  
100PCS/CTN, G.W/N.W: 29KG/28KG

QL501G

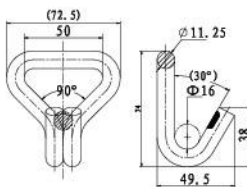

◆ Width: 50mm  
B/S: 5000KG  
100PCS/CTN, G.W/N.W: 23KG/24KG

QL502

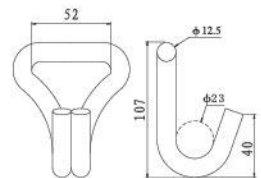

◆ Width: 50mm  
B/S: 5000KG  
70PCS/CTN, G.W/N.W: 26.5KG/25.5KG

QL507B

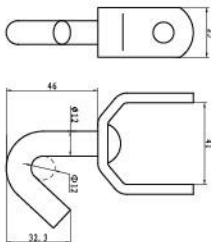

◆ B/S: 3000KG  
100PCS/CTN, G.W/N.W: 19.5KG/18.5KG

QL507C

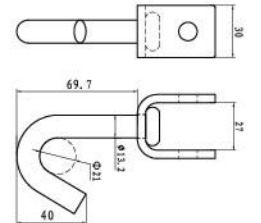

◆ B/S: 3000KG  
100PCS/CTN, G.W/N.W: 14.5KG/13.5KG

**QL508B**

◆ Width: 50mm  
B/S: 3000KG  
100PCS/CTN,G.W/N.W:21.5KG/20.5KG

**QL531**

◆ Width: 50mm  
B/S: 5000KG  
100PCS/CTN,G.W/N.W:25.5KG/24.5KG

**QL700**

◆ Width: 75mm  
B/S: 10000KG  
40PCS/CTN,G.W/N.W:26KG/25KG

**QL520**

◆ Width: 50mm  
B/S: 5000KG  
100PCS/CTN,G.W/N.W:27KG/26KG

**QL510**

◆ Width: 50mm  
B/S: 4000KG  
50PCS/CTN,G.W/N.W:25KG/24KG

**QL309+D19**

◆ Width: 50mm  
B/S: 5000KG  
50PCS/CTN,G.W/N.W:17.5KG/16.5KG

**QL802**

◆ Width: 50mm  
B/S: 2000KG  
100PCS/CTN,G.W/N.W:15KG/14KG

**QL255**

◆ Width: 25mm  
B/S: 1250KG  
1000PCS/CTN,G.W/N.W:24KG/23KG

**QLWH-001**

◆ Width: 2" B/S: 3T

**QLWH-002**

◆ Width: 2" B/S: 3T

**QLWH-003**

◆ Width: 2" B/S: 5T

**QLWH-004**

◆ S-Hook

**QLWH-005**

◆ S-Hook



# FLAT HOOK

**QL073**

◆ Width: 25mm  
B/S: 1250KG  
1000PCS/CTN,G.W/N.W:24KG/23KG

**QL010**

◆ Width: 25mm  
B/S: 1600KG  
200PCS/CTN,G.W/N.W:22KG/21KG

**QL074**

◆ Width: 25mm  
B/S: 350KG  
500PCS/CTN,G.W/N.W:19.5KG/18.5KG

**QL072**

◆ Width: 25mm  
B/S: 1600KG  
200PCS/CTN,G.W/N.W:15KG/14KG

**QL071**

◆ Width: 50mm  
B/S: 3000KG  
120PCS/CTN,G.W/N.W:21.5KG/20.5KG

**QL021**

◆ Width: 50mm  
B/S: 4500KG  
80PCS/CTN,G.W/N.W:26.5KG/25.5KG

**QL030**

◆ Width: 75mm  
B/S: 7000KG  
60PCS/CTN,G.W/N.W:25KG/24KG

**QL042**

◆ Width: 100mm  
B/S: 7000KG  
60PCS/CTN,G.W/N.W:28KG/27KG

**QLFH-001**

◆ Width: 50mm  
B/S: 1000KG

**QLFH-002**

◆ Width: 50mm  
B/S: 3000KG

**QLFH-003**

◆ Width: 50mm  
B/S: 4500KG

**QLFH-004**

◆ Width: 100mm  
B/S: 7000KG

**QL053A**

◆ Width: 25mm  
B/S: 2270KG  
200PCS/CTN,G.W/N.W:21KG/20KG

**QL051**

◆ Width: 50mm  
B/S: 2700KG  
200PCS/CTN,G.W/N.W:32.5KG/31.5KG

**QL032**

◆ Width: 50mm  
B/S: 5000KG  
100PCS/CTN,G.W/N.W:32KG/31KG

**QL034**

◆ Width: 35mm  
B/S: 3000KG  
100PCS/CTN,G.W/N.W:17KG/16KG

**QL031A**

◆ Width: 45mm  
B/S: 2200KG  
100PCS/CTN,G.W/N.W:16KG/15KG

**QL031**

◆ Width: 50mm  
B/S: 5000KG  
60PCS/CTN,G.W/N.W:20KG/19KG

**QLSH-01**

◆ Width: 45mm  
B/S: 2200KG

**QLSH-02**

◆ Clevis slip hook  
WLL: 3000KG

**QLSH-03**

◆ Ram's horn hook  
B/S: 5000KG

**QLSH-04**

◆ Eye sling hook  
WLL: 2000KG





**RING** //

**QL22**

◆ Square ring  
B/S: 2500KG  
200PCS/CTN,G.W/N.W:21KG/20KG

**QL12**

◆ Rectangle ring  
B/S: 2500KG  
200PCS/CTN,G.W/N.W:16KG/15KG

**QL13**

◆ Window ring  
B/S: 3000KG  
200PCS/CTN,G.W/N.W:19KG/18KG

**QL14**

◆ D ring  
B/S: 6000KG  
100PCS/CTN,G.W/N.W:27.5KG/26.5KG

**QLDR1**

◆ Eye ring  
B/S: 8500KG  
50PCS/CTN,G.W/N.W:18.5KG/17.5KG

**QL16**

◆ D ring  
B/S: 2700KG  
500PCS/CTN,G.W/N.W:15KG/14KG

**QL-061**

◆ Flat delta ring  
B/S: 5000KG  
250PCS/CTN,G.W/N.W:28KG/27KG

**Forged delta ring**

Item No.	B/S KG	A mm	B mm	C mm	D mm	Q'ty PCS/CTN	G.W KG	N.W KG
SYDR3	8000	79	59.2	16	15.2	50	17	16
SYDR4	9000	103	73.2	20	17.5	30	21	20

**D ring**

Item No.	B/S KG	A mm	B mm	C mm	Q'ty PCS/CTN	G.W KG	N.W KG
D14	1300	26	23	6	500	13.5	12.5
D15	1300	28.3	23.8	6.35	500	13	12
D18	2200	52.5	43	9	200	19	18
D18A	3600	52	48	10	200	25	24

O ring

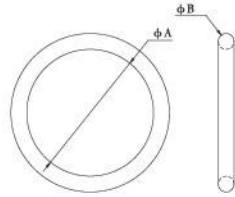

Item No.	B/S KG	A mm	B mm	Q'ty PCS/CTN	G.W KG	N.W KG
SYDR3A	4000	76	9.5	150	22	21
SYDR2A	2250	44.4	7.2	500	26	25
SYDR2B	4500	50	10	200	23	22

QLR-001



◆ Eye ring

QLR-002



◆ Eye ring

QLR-003



◆ Eye ring

QLR-004



◆ Eye ring

QLR-005



◆ O ring

QLR-006



◆ D ring

QLR-007



◆ D ring

QLR-008



◆ D ring

QLR-009



◆ D ring

QLR-010



◆ Snap hook carabiner

QLR-011



◆ Carabiner w/screw nut

QLR-012



◆ Snap hook w/eyelet







# E-TRACK SYSTEMS & ATTACHMENT



**QL028**

◆ Width: 25mm  
B/S: 1000KG  
1000PCS/CTN,G.W/N.W:9KG/8KG

**QL013**

◆ Width: 25mm  
B/S: 1100KG  
500PCS/CTN,G.W/N.W:16KG/15KG

**QL023**

◆ Width: 50mm  
B/S: 2200KG  
300PCS/CTN,G.W/N.W:20.5KG/19.5KG

**QL024**

◆ Width: 50mm  
B/S: 3000KG  
300PCS/CTN,G.W/N.W:16KG/15KG

**QL019**

◆ Width: 45mm  
B/S: 800KG  
400PCS/CTN,G.W/N.W:17KG/16KG

**QLF1017**

◆ Series E/A spring fitting  
B/S: 2000KG  
300PCS/CTN,G.W/N.W:29KG/28KG

**QL1010**

◆ Series E/A 3-piece fitting  
B/S: 1350KG  
300PCS/CTN,G.W/N.W:16KG/15KG

**QL092**

◆ Series F track hook  
B/S: 1000KG  
200PCS/CTN,G.W/N.W:17KG/16KG

**QL018A**

◆ Series F butterfly track fitting  
B/S: 900KG  
800PCS/CTN,G.W/N.W:25KG/24KG

**QL01**

◆ Double stud fitting  
B/S: 2700KG  
250PCS/CTN,G.W/N.W:23.5KG/22.5KG



# TRACK FITTINGS

QL02

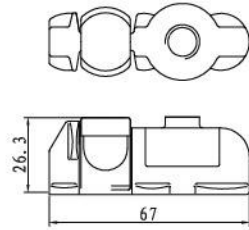

◆ B/S: 3000KG  
200PCS/CTN,G.W/N.W:31KG/20KG

QL03

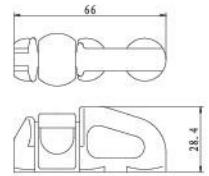

◆ Double stud fitting  
B/S: 2700KG  
220PCS/CTN,G.W/N.W:28.5KG/27.5KG

QL01-0

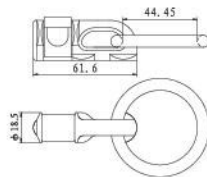

◆ Double stud fitting W/O ring  
B/S: 2700KG  
200PCS/CTN,G.W/N.W:28KG/27KG

QL01-P

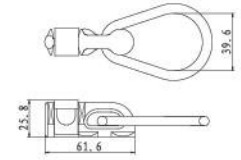

◆ Double stud fitting W/pear ring  
B/S: 2700KG  
200PCS/CTN,G.W/N.W:24.5KG/23.5KG

QL03-P

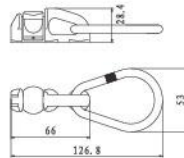

◆ Double stud fitting W/pear ring  
B/S: 2700KG  
150PCS/CTN,G.W/N.W:26.5KG/25.5KG

QL08

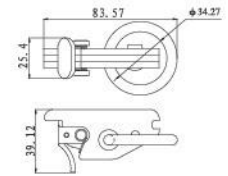

◆ Series E/A fitting W/O ring  
B/S: 2700KG  
100PCS/CTN,G.W/N.W:20KG/19KG

QL07

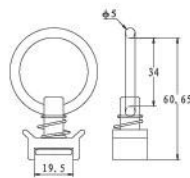

◆ Single stud fitting W/O ring  
B/S: 1500KG  
500PCS/CTN,G.W/N.W:24.5KG/23.5KG

QL07C

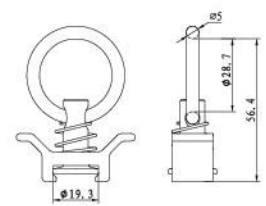

◆ Stud Fitting Single,  
Aluminum With Round Ring.  
200PCS/CTN,G.W/N.W:10KG/9KG

QL1018B

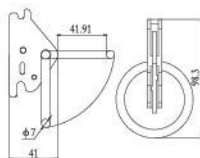





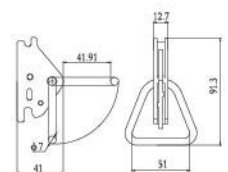











◆ Series E/A fitting W/O ring  
B/S: 1850KG  
100PCS/CTN,G.W/N.W:15.5KG/15KG

QL1018A



◆ Series E/A fitting W/Triangle ring  
B/S: 1850KG  
100PCS/CTN,G.W/N.W:15.5KG/15KG

<p>QLTF-001</p>  <p>◆ Tool holder for E track</p>	<p>QLTF-002</p>  <p>◆ Series E/A fitting W/O ring B/S: 900KG</p>	<p>QLTF-003</p>  <p>◆ E track J Hook Fitting</p>	<p>QLTF-004</p>  <p>◆ E track J Hook Fitting</p>
<p>QLTF-005</p>  <p>◆ E track J Hook Fitting</p>	<p>QLTF-006</p>  <p>◆ Series E/A spring fitting B/S: 2000KG</p>	<p>QLTF-007</p>  <p>◆ Series E/A spring fitting B/S: 2000KG</p>	<p>QLTF-008</p>  <p>◆ Series E/A spring fitting B/S: 2000KG</p>
<p>QLTF-009</p>  <p>◆ D ring</p>	<p>QLTF-010</p>  <p>◆ Bolt plate</p>	<p>QLTF-011</p>  <p>◆ Lashing strap slide buckle</p>	<p>QLTF-012</p>  <p>◆ Action spring buckle strap</p>
<p>QLTF-013</p>  <p>◆ E Track spare tire holder mount</p>	<p>QLTF-014</p>  <p>◆ Wood end socket for E track</p>	<p>QLTF-015</p>  <p>◆ Single stud fitting W/D ring</p>	<p>QLTF-016</p>  <p>◆ Single stud fitting W/O ring</p>





# RECESSED PAN FITTING

**QL08**

◆ B/S: 700KG  
150PCS/CTN,G.W/N.W:13.5KG/12.5KG

**QL11**

◆ B/S: 550KG  
200PCS/CTN,G.W/N.W:27KG/26KG

**QL10**

◆ B/S: 2250KG  
40PCS/CTN,G.W/N.W:21KG/20KG

**QL06**

◆ B/S: 2500KG  
50PCS/CTN,G.W/N.W:33.5KG/32.5KG

**QL01**

◆ B/S: 6000KG  
30PCS/CTN,G.W/N.W:25.5KG/24.5KG

**QL05**

◆ B/S: 2500KG  
50PCS/CTN,G.W/N.W:29.5KG/28.5KG

**QL03**

◆ B/S: 6000KG  
30PCS/CTN,G.W/N.W:23.5KG/22.5KG

**QL09**

◆ B/S: 2500KG  
30PCS/CTN,G.W/N.W:28KG/27KG

**QL36A**

◆ Chrome Toggle Anchor Point,Bulk  
8PCS/CTN,G.W/N.W:2.0KG/1.5KG

**QL07**

◆ B/S: 5000KG  
50PCS/CTN,G.W/N.W:31KG/30KG

**QLE100T**

Steel Tube Series E Beam  
Adjustable Range:91.5" to 102.5"

Decking/Vertical W.L.L.:1500lbs/680kgs  
Shoring/Horizontal W.L.L.:1500lbs/680kgs  
60pcs/pallet,G.W/N.W:960kgs/940kgs,26cuft



**QLE100L**

Aluminum Tube Series E Beam  
Adjustable Range:85.5" to 96.5"

Decking/Vertical W.L.L.:2200lbs/1000kgs  
Shoring/Horizontal W.L.L.:2200lbs/1000kgs  
100pcs/pallet,G.W/N.W:830kgs/790kgs,42cuft



**QLE100LH**

Heavy Duty Aluminum Tube Series E Beam  
Adjustable Range:83.7" to 94.7"

Decking/Vertical W.L.L.:3000lbs/1360kgs  
Shoring/Horizontal W.L.L.:2500lbs/1130kgs  
100pcs/pallet,G.W/N.W:1200kgs/1160kgs,42cuft



Item No.	Steel Plate Thickness,mm	Length mm	Q'ty pcs/ctn	G.W kgs	N.W kgs	Volume cuft
SYE-1	3	314.5	14	25.5	24.5	0.73
SYE-2	3.5	314.5	14	27	26	0.73
SYE-3	4	314.5	14	29	28	0.73
SYE-7	3	457.2	10	25.5	24.5	0.73

**E BEAM END**



**SYE-G**



◆ Locking Beam End  
10pcs/ctn,G.W/N.W:27.5kgs/26.5kgs, 0.7cuft

**SYE-PIN**



◆ Attaching Pin  
500pcs/ctn,G.W/N.W:30kgs/29kgs, 0.3cuft

**SYE-CL**



◆ Insert Tube  
10pcs/ctn,G.W/N.W:16kg/15kg



## SERIES F BARS //

### QLF100

Steel Round Series F Bar  
Adjustable Range:96" to 111"  
W.L.L.:500lbs/227kgs, Tube Diameter:1.66"  
100pes/pallet, G.W/N.W:940kgs/920kgs, 14.5cuft



### QLF101

Steel Square Series F Bar  
Adjustable Range:96" to 111"  
W.L.L.:1000lbs/454kgs, Tube Diameter:2"  
80pes/pallet, G.W/N.W:1020kgs/1000kgs, 17.5cuft



### QLF200D

F Track Shoring Bar W/handles 24mm Ends 2172mm-2631mm  
100pcs/pallet, G.W/N.W:685kg/675kg



## WOOD BEAM SOCKET //

Item No.	B/S lbs	A (mm)	B (mm)	C (mm)	D (mm)	Q'ty pcs/ctn	G.W kgs	N.W kgs
SYS-1	1400	110	84.4	48.9	12	40	19	18
SYS-2	1400	110	84.4	48.9	12	40	18.5	17.5
SYS-3	1400	110	84.4	96.5	12	40	24	23

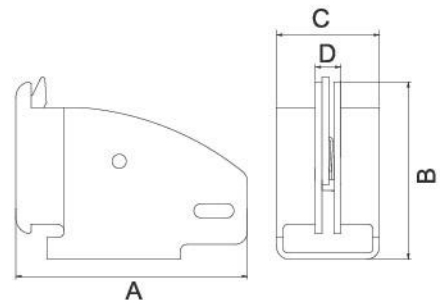

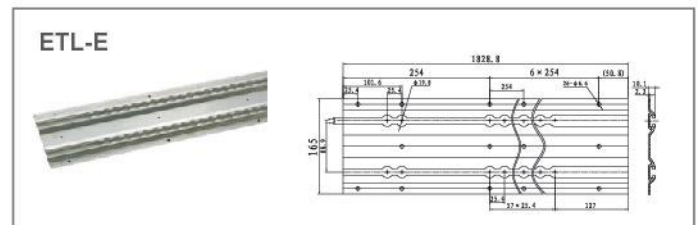
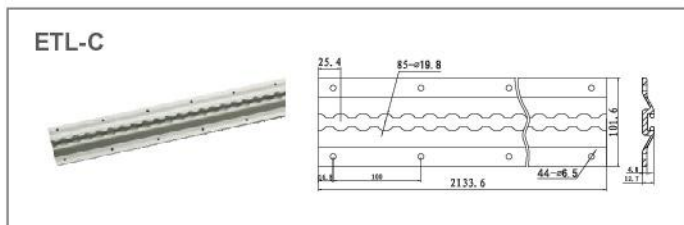
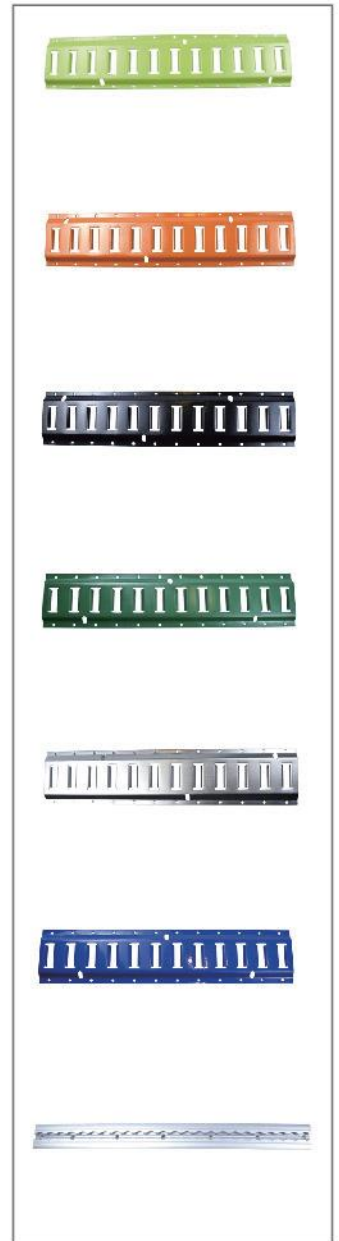
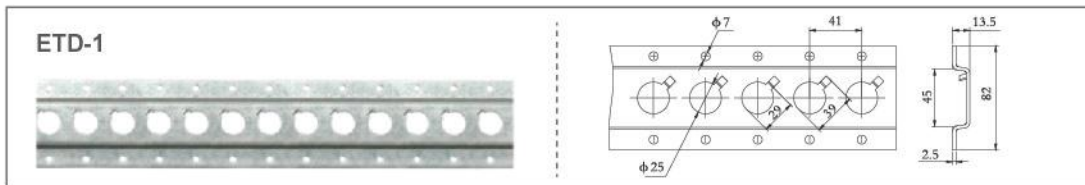
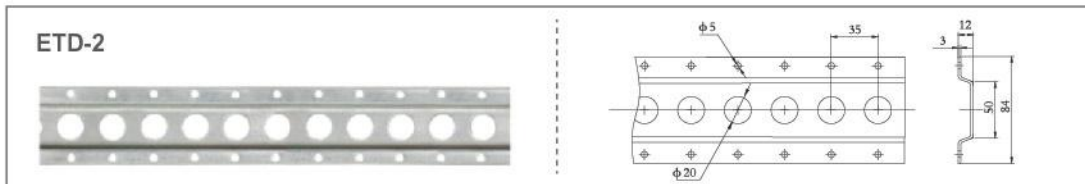
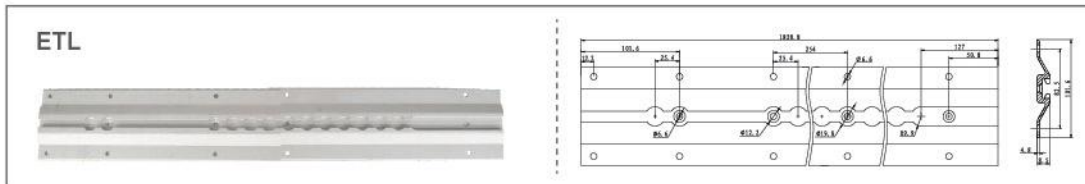
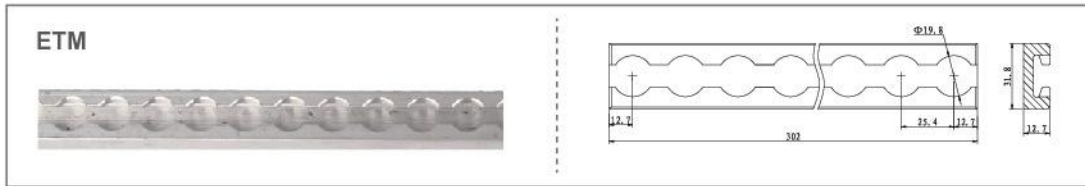
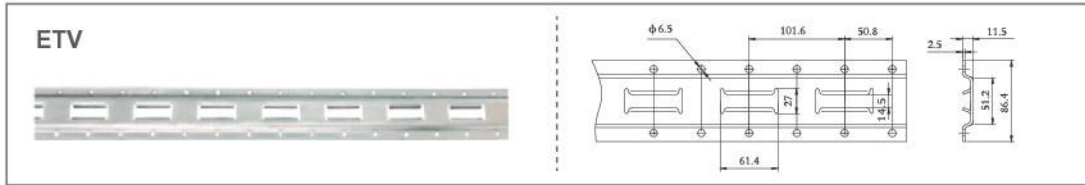
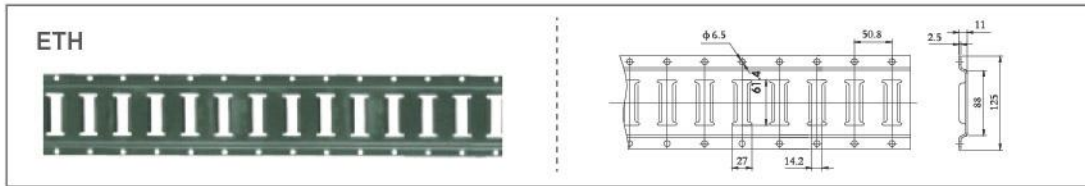



# CHAIN



# CHAIN BINDER



Item No.	Part No	Chain	Accessories Forged Hook	Connecting Ring	Working Length (mm)	B/S (KG)	Surface Treatment	Net Weight (kg)	Gross Weight (kg)	Package
83001	CA12-2	27X12.6X8	3/8	50.5	290	4690	Dichromate plated	21.2	22.2	25
83031	CA18B-2	24X11X8	3/8	53	800	4690	Dichromate plated	22.8	23.8	15



Item No.	Part No	Chain	Accessories Forged Hook	Connecting Ring	Working Length (mm)	B/S (KG)	Surface Treatment	Net Weight (kg)	Gross Weight (kg)	Package
83009	CA18	27X12.6X8	3/8	Elliptical ring	468	7500	Dichromate plated	18.9	19.9	/



Item No.	Part No	Chain	Accessories Forged Hook	Connecting Ring	Working Length (mm)	B/S (KG)	Surface Treatment	Net Weight (kg)	Gross Weight (kg)	Package
83010	CA18-1	30X13X10	3/8	75	450	7350	Dichromate plated	21.7	22.7	/
83013	CA18-3	30X13X10	3/8	105	2640	7350	Dichromate plated	26.2	27.2	/
83014	CA18-4	30X13X10	3/8	105	457	7440	Dichromate plated	18	19	/
83015	CA18-5	38X18X11	3/8	79	168	7350	Dichromate plated	16.3	17.3	/
83016	CA18-6	38X18X11	3/8	110	155	7350	Dichromate plated	23.2	24.2	/

























Item No.	Part No	Accessories Forged Hook	Connecting Ring	Working Length (mm)	B/S (KG)	Surface Treatment	Net Weight (kg)	Gross Weight (kg)	Package
83017	CA19	9.5	66 62 12	130	7500	Dichromate plated	17	18	30
83017	CA19-5	16	61 58 11	157	5440	Dichromate plated	20.4	21.4	50
83017	CA19-6	16	55 31 10	155	5440	Dichromate plated	17.5	18.5	50

<p><b>G70</b> 3/8"</p> <p>3/8"X20' G70 TRANSPORT CHAIN WITH CLEVIS GRAB HOOKS</p>	<p><b>G70</b> 3/8"</p> <p>3/8"X16' G70 TRANSPORT CHAIN WITH CLEVIS GRAB HOOKS</p>	<p><b>G70</b> 1/2"</p> <p>1/2"X20' G70 TRANSPORT CHAIN WITH CLEVIS GRAB HOOKS</p>	<p><b>G70</b> 5/16"</p> <p>5/16"X20' G70 TRANSPORT CHAIN WITH CLEVIS GRAB HOOKS</p>	<p><b>G70</b> 3/8"</p> <p>3/8"X25' G70 TRANSPORT CHAIN WITH CLEVIS GRAB HOOKS</p>
---	---	---	---	---



# CHAIN ANCHOR //

 <p><b>G70</b> 5/16"</p> <p>5/16"X16' G70 TRANSPORT CHAIN WITH CLEVIS GRAB HOOKS</p>	 <p><b>G70</b> 1/2"</p> <p>1/2"X25' G70 TRANSPORT CHAIN WITH CLEVIS GRAB HOOKS</p>	 <p><b>G80</b> 3/8"</p> <p>3/8"X10' G80 TIE DOWN CHAIN WITH CLEVIS GRAB HOOKS</p>	 <p><b>G80</b> 5/8"</p> <p>5/8"X10' G80 TIE DOWN CHAIN WITH CLEVIS GRAB HOOKS</p>	 <p><b>G80</b> 3/8"</p> <p>3/8"X20' G80 TIE DOWN CHAIN WITH CLEVIS GRAB HOOKS</p>
 <p><b>G100</b> 1/2"</p> <p>1/2"X10' G100 TIE DOWN CHAIN WITH CLEVIS GRAB HOOKS</p>	 <p><b>G100</b> 3/8"</p> <p>3/8"X16' G100 TIE DOWN CHAIN WITH CLEVIS GRAB HOOKS</p>	 <p><b>G100</b> 3/8"</p> <p>3/8"X10' G100 TIE DOWN CHAIN WITH CLEVIS GRAB HOOKS</p>	 <p><b>G70</b> 3/8"</p> <p>3/8"X16' G70 TRANSPORT CHAIN AND BINDER KIT</p>	 <p><b>G70</b> 3/8"</p> <p>3/8"X20' G70 TRANSPORT CHAIN AND BINDER KIT</p>
 <p><b>G70</b> 5/16"</p> <p>5/16"X20' G70 TRANSPORT CHAIN AND BINDER KIT</p>	 <p><b>G70</b> 1/2"</p> <p>1/2"X20' G70 TRANSPORT CHAIN AND BINDER KIT</p>	 <p><b>CHAIN BINDER //</b></p>		
 <p><b>3/8"</b></p> <p>3/8"CHAIN BINDER</p>	 <p><b>5/16"</b></p> <p>5/16"CHAIN BINDER</p>	 <p><b>1/2"</b></p> <p>1/2"CHAIN BINDER</p>	 <p><b>3/8"</b></p> <p>3/8"CHAIN BINDER</p>	 <p><b>5/16\"-3/8"</b></p> <p>HEAVY DUTY CHAIN BINDER</p>
 <p><b>5/16\"-3/8"</b></p> <p>5/16"-3/8" RECOIL-LESS CAM ACTION LEVER BINDER /SNAP BINDER</p>	 <p><b>1/4"</b></p> <p>1/4"LEVER BINDER / SNAP BINDER</p>	 <p><b>5/16"</b></p> <p>5/16"LEVER BINDER / SNAP BINDER</p>	 <p><b>3/8"</b></p> <p>3/8"LEVER BINDER / SNAP BINDER</p>	 <p><b>1/2"</b></p> <p>1/2"LEVER BINDER / SNAP BINDER</p>







# CORNER PROTECTOR

<p>QLCP-01</p>  <p>◆ 4" 89G Corner protector</p>	<p>QLCP-02</p>  <p>◆ 4" 89G Corner protector</p>	<p>QLCP-03</p>  <p>◆ 4" 89G Corner protector</p>	<p>QLCP-04</p>  <p>◆ 4" 89G Corner protector</p>
<p>QLCP-05</p>  <p>◆ 11" Corner protector</p>	<p>QLCP-06</p>  <p>◆ 12" 420G Corner protector</p>	<p>QLCP-07</p>  <p>◆ 24" Corner protector</p>	<p>QLCP-08</p>  <p>◆ 36" Corner protector</p>
<p>QLCP-09</p>  <p>◆ 24" 965G Corner protector</p>	<p>QLCP-10</p>  <p>◆ 6" 144G Corner protector</p>	<p>QLCP-11</p>  <p>◆ 2" 21G Corner protector</p>	<p>QLCP-12</p> 
<p>QLCP-13</p>  <p>◆ 4" Corner protector</p>	<p>QLCP-14</p>  <p>◆ 4" Corner protector</p>	<p>QLCP-15</p>  <p>◆ 6" 160G Corner protector</p>	<p>QLCP-16</p>  <p>◆ 12" Corner protector</p>







# TRUCK WINCH

TW419 	TW419D 	TW419N 	TW420 	TW434 
TW434N 	TW401 	TW410 	TW412 	TW414 
TW415 	TW416 	TW421 	TW421H 	TW422 
TW428 	TW432 	TW433 	TW445 	TW426 
TW427 	TW435-1 	TW410Z 	TW412 	TW452 



# LASHING WINCH //

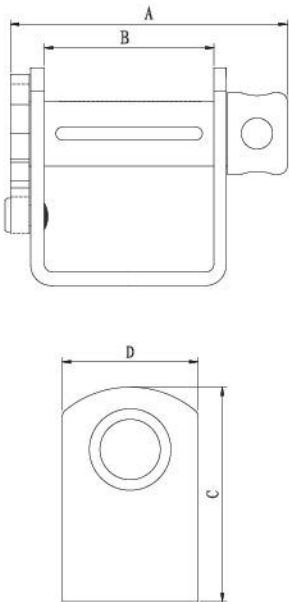

Item No.	A (mm)	B (mm)	C (mm)	D (mm)	Q'ty pcs/ctn	G.W kgs	N.W kgs
TW410	204	124	140	90	5	20.5	19.5
TW401	204	124	158	90	5	22	21
TW411	204	124	140	90	5	21.5	20.5
TW402	204	124	158	90	5	24.5	23.5
TW41860	206	124	140	90	5	22.5	21.5
TW419	204	124	175	100	5	24.3	23.3
TW420	204	124	190	100	5	26.5	25.5
TW41820	273	195	155	100	5	28.5	27.5
TW449	265	165	155	100	5	32	31
TW450	309	165	155	100	5	34	33
TW452	257	180	155	100	4	27	26
TW451	175	76	150	100	5	21	20
TW415	230	60	200	70	5	17.5	16.5
TW41890	225	84	225	100	5	28	27
TW200	125	53	102	75	20	32	31
TW200A	149.5	53	102	75	20	35	34
TW201	132	53	102	75	20	33	32
TW201A	128	53	102	75	20	28	27
TW202	125	53	102	75	20	32	31
TW202B	125	53	114.3	75	20	32.5	31.5
W5-1	160	58	100	60	20	27	26
CW5B-2S	174	63	100	60	20	37	36
CW5-1S	160	58	140	60	20	39	38
CW5-2S	125	58	100	70	12	26.2	25.2



# FLAT TARPS



# FLAT TARPS //

<p>18oz</p>  <p>16'X28'(4'DROP &amp; FLAP)</p>	<p>18oz</p>  <p>20'X18'(6'DROP &amp; FLAP)</p>	<p>18oz</p>  <p>20'X18'(6'DROP &amp; FLAP)</p>	<p>18oz</p>  <p>24'X18'(8'DROP &amp; FLAP)</p>	<p>14oz</p>  <p>16'X28'(4'DROP &amp; FLAP)</p>
<p>14oz</p>  <p>20'X20'(6'DROP &amp; FLAP)</p>	<p>14oz</p>  <p>20'X28'(6'DROP &amp; FLAP)</p>	<p>14oz</p>  <p>24'X20'(8'DROP &amp; FLAP)</p>	<p>14/18 oz</p>  <p>20'X28'(6'DROP &amp; FLAP)</p>	<p>14/18 oz</p>  <p>24'X28'(8'DROP &amp; FLAP)</p>
<p>6/18 oz</p>  <p>25'X27'(8'DROP &amp; FLAP)</p>	<p>6/18 oz</p>  <p>20'X27'(6'DROP &amp; FLAP)</p>	<p>14oz</p>  <p>24'X18'(6'DROP); MID:24'X18'</p>	<p>14oz</p>  <p>24'X20'(8'DROP); MID:24'X18'</p>	<p>18oz</p>  <p>20'X18'(6'DROP)</p>
<p>18oz</p>  <p>24'X18'(8'DROP)</p>	<p>18oz</p>  <p>20'X18'(6'DROP)</p>	<p>18oz</p>  <p>24'X18'(6'DROP)</p>	<p>14oz</p>  <p>16'X27'(4'DROP)</p>	<p>14oz</p>  <p>20'X16'(6'DROP)</p>
<p>18oz</p>  <p>16'X27'(4'DROP-4-SIDED)</p>	<p>18oz</p>  <p>16'X28'(6'DROP &amp; FLAP)</p>	<p>14/18 oz</p>  <p>24'X28'(8'DROP &amp; FLAP)</p>	<p>18oz</p>  <p>6'X6'X6'</p>	<p>18oz</p>  <p>7'X7'X7'</p>



**RATCHET STRAP / LOGISTICS STRAP / WINCH STRAP / LIFTING STRAP / CARGO CONTROL ACCESSORIES**

---



**NINGBO FORCE RIGGING CO., LTD.**  
**NINGBO FORCE AUTO PARTS CO., LTD.**

---

Joe du

E-mail: [joe@forcerigging.com](mailto:joe@forcerigging.com)

Web: [www.forcerigging.com](http://www.forcerigging.com)

Add: No. 469, Liansheng Road, Binhai Development Zone,  
Yinzhou District, Ningbo, ZheJiang Province, China.